

# AsteRx2 Product Family Hardware Manual

---

Version 2.10.1

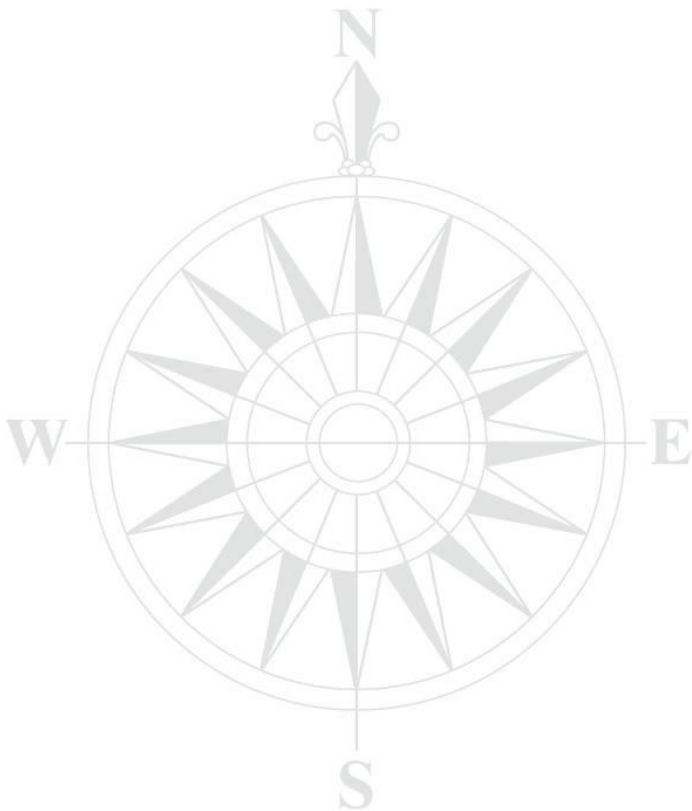

## AsteRx2 Product Family Hardware Manual

Version 2.10.1  
April 08, 2014

© Copyright 2000-2014 Septentrio nv/sa. All rights reserved.

Septentrio Satellite Navigation  
Greenhill Campus, Interleuvenlaan 15G  
B-3001 Leuven, Belgium

<http://www.septentrio.com>

support@septentrio.com

Phone: +32 16 300 800

Fax: +32 16 221 640

# Table of contents

<b>TABLE OF CONTENTS .....</b>	<b>3</b>
<b>1 ASTERX2E_HDC, ASTERX2EL_HDC &amp; ASTERX2I_HDC .....</b>	<b>8</b>
1.1 Connectors .....	9
1.2 Cables .....	11
1.3 Stand-By Mode .....	14
1.4 SD Memory Card Usage .....	15
1.5 Applicable Software Package .....	15
1.6 Hardware Specifications .....	15
1.6.1 Power Consumption .....	15
1.6.2 Environmental .....	15
<b>2 ASTERX2EH_PRO .....</b>	<b>16</b>
2.1 Rear Panel Connectors.....	16
2.1.1 MAIN and AUX (TNC) .....	16
2.1.2 PPS OUT (BNC) .....	17
2.1.3 REF IN (BNC).....	17
2.1.4 REF OUT (BNC).....	17
2.2 Front Panel Connectors .....	18
2.2.1 COM1 .....	18
2.2.2 COM2.....	19
2.2.3 COM3-4/USB.....	19
2.2.4 ETH.....	20
2.2.5 OUT.....	20
2.2.6 IN.....	20
2.2.7  .....	20
2.2.8 PWR .....	21
2.3 Log Button .....	21
2.4 Power Button .....	21
2.5 Status LEDs .....	21
2.6 Cables .....	21
2.7 Internal Logging on SD Memory Card .....	23
2.8 Applicable Software Package .....	23
2.9 Hardware Specifications .....	23
<b>3 ASTERX2E_OEM &amp; ASTERX2I_OEM.....</b>	<b>24</b>
3.1 Mechanical Drawings.....	24

<b>3.2</b>	<b>Electrical Specifications .....</b>	<b>26</b>
<b>3.3</b>	<b>Applicable Software Package .....</b>	<b>26</b>
<b>3.4</b>	<b>Hardware Specifications .....</b>	<b>26</b>
3.4.1	Power Consumption .....	26
3.4.2	Temperature Range.....	26
<b>3.5</b>	<b>IMU Cable (AsteRx2i_OEM only).....</b>	<b>26</b>
<b>4</b>	<b>ASTERX2EH_OEM.....</b>	<b>27</b>
<b>4.1</b>	<b>Mechanical Drawings.....</b>	<b>27</b>
<b>4.2</b>	<b>Electrical Specifications .....</b>	<b>30</b>
<b>4.3</b>	<b>Applicable Software Package .....</b>	<b>30</b>
<b>4.4</b>	<b>Hardware Specifications .....</b>	<b>30</b>
4.4.1	Power Consumption .....	30
4.4.2	Temperature Range.....	30
<b>5</b>	<b>ASTERX2EL_OEM .....</b>	<b>31</b>
<b>5.1</b>	<b>Mechanical Drawings.....</b>	<b>31</b>
<b>5.2</b>	<b>Electrical Specifications .....</b>	<b>33</b>
<b>5.3</b>	<b>Applicable Software Package .....</b>	<b>33</b>
<b>5.4</b>	<b>Hardware Specifications .....</b>	<b>33</b>
5.4.1	Power Consumption .....	33
5.4.2	Temperature Range.....	34
<b>APPENDIX A OEM RECEIVERS ELECTRICAL SPECIFICATIONS.....</b>		<b>35</b>
<b>A.1</b>	<b>Antenna Connector .....</b>	<b>35</b>
<b>A.2</b>	<b>80-pin Connector .....</b>	<b>35</b>
<b>A.3</b>	<b>Frequency Reference Selection.....</b>	<b>38</b>
<b>A.4</b>	<b>Ethernet (only for AsteRx2eL_OEM and AsteRx2eH_OEM).....</b>	<b>38</b>
<b>A.5</b>	<b>Stand-By Mode .....</b>	<b>38</b>
<b>A.6</b>	<b>SD Memory Card Usage .....</b>	<b>39</b>
<b>APPENDIX B LED STATUS INDICATORS.....</b>		<b>41</b>

## CE NOTICE

Receivers of the AsteRx2 family carry the CE mark and are as such compliant with the 2004/108/EC - EMC Directive and amendments, 2006/95/EC - Low Voltage Directive, both amended by the CE-marking directive 93/68/EC.

With regards to EMC, these devices are declared as class B, suitable for residential or business environment.

## ROHS/WEEE NOTICE



Receivers of the AsteRx2 family comply with European Union (EU) Directive 2002/95/EC on the restriction of the use of certain hazardous substances in electrical and electronic equipment (RoHS Directive).



Receivers of the AsteRx2 family comply with the European Union (EU) Directive 2002/96/EC on waste electrical and electronic equipment (WEEE). The purpose of this Directive is the prevention of waste electrical and electronic equipment (WEEE), and in addition, the reuse, recycling and other forms of recovery of such wastes so as to reduce the disposal of waste. If purchased in the European Union, please return the receiver at the end of its life to the supplier from which it was purchased.

## SAFETY INFORMATION



Statement 0000/WARNING: IMPORTANT SAFETY INSTRUCTIONS

This warning symbol means danger and indicates that you are in a situation that may result in body injury and physical damage. Before you work on any equipment, be aware of the hazards involved with electrical circuitry and familiarize yourself with standard practices for preventing accidents. Use the statement number provided at the beginning of each warning to locate its translation in the translated safety warnings that accompanied this device.

---



Statement 0001/WARNING: The power supply provided by Septentrio (if any) should not be replaced by another. If you are using the receiver with your own power supply, it must have a double isolated construction and must match the specifications of the provided power supply.

---



Statement 0003/WARNING: Ultimate disposal of this product should be handled according to all national laws and regulations.

---



Statement 0005/WARNING: The equipment and all the accessories included with the product may only be used according to the specifications in the delivered release note, in the manual and in all other documents delivered with the receiver.

---



Statement 0007/WARNING: Never place the equipment in direct sunlight.

---



Statement 0008/WARNING: The outside of the instrument may be cleaned using a clean, lightly dampened cloth. Do not use any cleaning liquids containing alcohol, methylated spirit, ammonia etc.

---

## WARNING: Handling of ESD Sensitive Devices

Electrostatic discharge is a sudden flow of current from one object to another either object or to ground. Electrostatic charges can accumulate on common items such as polystyrene drinking cups, cellophane tape, synthetic clothing, untreated foam packaging material, and untreated plastic bags and work folders, to name but a few.

Electronic components and assemblies, such as Septentrio OEM receivers, can be permanently damaged or destroyed when near or in contact with electro-statically charged objects. When you handle components or assemblies that are not in protective bags and you are not sure whether they are static-sensitive, assume that they are static-sensitive and handle them accordingly.

Everyone who is working with ESD-sensitive devices must be aware of these rules.



### General rules

Always test your ground strap, bench mat, conductive work surface, and ground cord before either removing components and assemblies from their protective bags or before beginning any disassembly or assembly procedures. Perform all service procedures in a static-protected environment. Always use techniques and equipment designed to protect personnel and equipment from electrostatic discharge.

### Handling

- Remove static-sensitive components and assemblies from their static-shielding bags only at static-safe workstations - a properly grounded table and grounded floor mat - and only when you are wearing a grounded wrist strap (with a resistor of at least 1 mega-ohm in series) or other grounding device. Avoid having non-ESD safe material on the workbench. Clear the work station of static generators like e.g. polyethylene, vinyl's, foam, notebooks, document holders, etc.
- Use only grounded tools when manipulating static-sensitive components and assemblies.
- Place and seal static-sensitive components and assemblies in their original static-shielding bags before removal from static-protected areas.
- Stacking of board assemblies should be avoided to prevent physical damage to devices.

### Transport & Storage

- Limit as much as possible the manipulation of ESD-sensitive devices and components.
- Handle ESD-sensitive parts as far as possible in their (original) protective packaging.
- Protect ESD-sensitive components against dust as this is a possible carrier of static loads. Assembled printed circuit boards (PCB's) must always be placed in an anti-static shielding bag, box or PCB containers during transport between workplaces or to a warehouse.

# 1 AsteRx2e\_HDC, AsteRx2eL\_HDC & AsteRx2i\_HDC

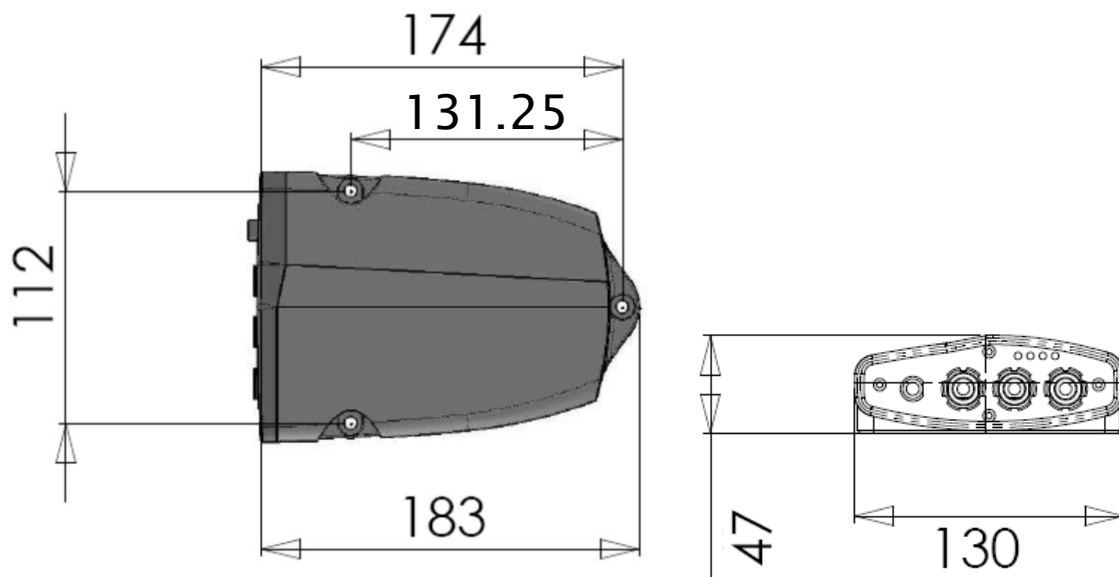

All dimensions expressed in millimeters.

Mounting holes:      hole diameter: 6mm.  
                              max diameter of screw head: 11mm.

Weight: 500g



## 1.1 Connectors

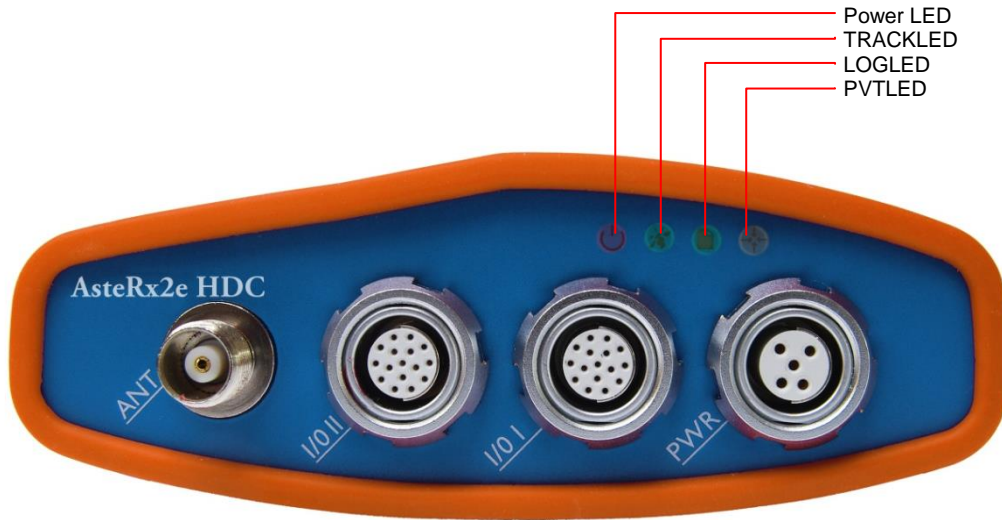

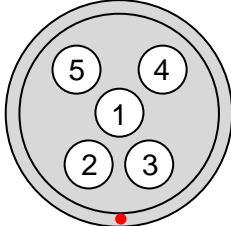
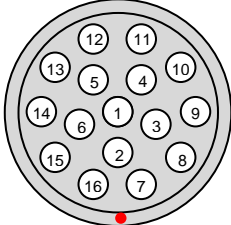
Connector	Type
PWR	ODU MINI-SNAP Series F, 5 pins, part number male connector: S42F1C-T05MPHO-90CP  <p>Pinout of the female connector.</p>
I/O I I/O II	ODU MINI-SNAP Series F, 16 pins, part number male connector: S42F1C-T16MFDO-90CS  <p>Pinout of the female connector.</p>
ANTENNA	TNC

**!** The functionalities marked yellow in the tables below are only available if the input/output board inside your receiver is of type BIO0019x. If it is of type BIO0008x, the pins are reserved and must be left unconnected. Please check your Input/Output board version in the Product Group Hardware Release Notes on the CD shipped with your receiver, section “Hardware Deliverables”.

PWR				
Pin#	Name	I/O type	Level	Comment
1	Ground	P	0V	
2	Power1_In	P	9 – 30V	Main power input.
3	Power2_In	P	9 – 30V	Backup power input. The receiver automatically switches to Power2_In when the voltage at Power1_In drops below 7V.
4	Reserved			To be tied to ground for proper operation.
5	Vantenna	P	0 – 12 V	If not connected, a 5-V DC supply is applied to the central conductor of the TNC antenna connector. If Vantenna > 4V, the applied voltage is transferred to the antenna connector. Max current: 200mA.

Note: I/O type: I=input, O=output, P=power.

I/O I				
Pin#	Name	I/O type	Level	Comment
1	Ground	P	0V	
2	COM1_RX	I	RS232	Serial COM 1 receive line (as seen from receiver side)
3	COM1_TX	O	RS232	Serial COM 1 transmit line (as seen from receiver side)
4	USB_D+	I/O	USB	USB data signal positive D+
5	USB_D-	I/O		USB data signal negative D-
6	USB_Vbus	I	$4.35V \leq V_{high} \leq 5.25V$	USB Power. Cannot be used to power the receiver.
7	nRST_In	I	LVTTL, pulled up	Pulling this pin down for at least 1ms and then releasing it resets the receiver.
8	ETH_TX+	I/O	Ethernet	Ethernet_TX+ (only on AsteRx2eL_HDC)
9	ETH_TX-	I/O		Ethernet_TX- (only on AsteRx2eL_HDC)
10	ETH_RX+	I/O		Ethernet_RX+ (only on AsteRx2eL_HDC)
11	ETH_RX-	I/O		Ethernet_RX- (only on AsteRx2eL_HDC)
12	Ground	P	0V	
13	GPLED	O	LVTTL	General-purpose status indicator, see Appendix B.
14	PVTLED	O	LVTTL	PVT status indicator, see Appendix B. Functionality not available on BIO0019x.
15	TRACKLED	O	LVTTL	Tracking status indicator, see Appendix B. Functionality not available on BIO0019x.
16	PowerOut	P	5V	Power output, maximum current 200mA

Note: I=input, O=output, P=power, PU=pull up, PD=pull down.

I/O II				
Pin#	Name	I/O type	Level	Comment
1	Ground	P	0V	
2	COM2_RX	I	RS232	Serial COM 2 receive line (as seen from receiver side)
3	COM2_TX	O	RS232	Serial COM 2 transmit line (as seen from receiver side)
4	EventA	I	BIO0008: LVTTL, PD BIO0019: 0-30V	Event A input (see Firmware User Manual for operation instructions)
5	EventB	I	BIO0008: LVTTL, PD BIO0019: 0-30V	Event B input (see Firmware User Manual for operation instructions)
6	Reserved			
7	Button	I	LVTTL, no pull up/down	“Button” pin of the receiver (see Firmware User Manual). High to low transitions are detected as “button pressed” events.
8	COM3_RX	I	RS232	Serial COM 3 receive line (as seen from receiver side)
9	COM3_CTS	I	RS232	Serial COM 3 CTS line
10	COM3_TX	O	RS232	Serial COM 3 transmit line (as seen from receiver side)
11	COM3_RTS	O	RS232	Serial COM 3 RTS line
12	Ground	P	0V	
13	nRST_Out	O	LVTTL	This line is tied to ground when the receiver is resetting, and left in tri-state in normal operation
14	Reserved			
15	xPPS_Out	O	5V-TTL	Pulse per second output, see Firmware User Manual. Pulse duration: 2ms.
16	PowerOut	P	5V	Power output, maximum current 200mA

Note: I=input, O=output, P=power, PU=pull up, PD=pull down.

### ANTENNA

The gain of the antenna element together with its low noise amplifier and cable losses summed up until receiver connector must be between 15 and 50 dB.

The receiver provides a 5V DC supply by default (see also the Vantenna pin of the PWR connector). Maximum current is 200mA.



Never inject a DC voltage into the ANT connector as it may damage the receiver. For instance, when using a splitter to distribute the antenna signal to multiple receivers, make sure that no more than one output of the splitter passes DC. Use DC-blocks otherwise.

### LEDs

The functionality of the LEDs is described in Appendix B.

## 1.2 Cables

When installing the receiver, make sure to allow space for the connectors and cables. At least 10cm free space is needed in front of the receiver front panel to avoid excessive cable bending. The length of the male ODU connector and of the bend relief is shown below.

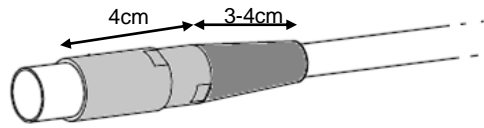

Cable Name: CBL*_HDC_PWR_OE	Part #: 201045
-----------------------------	----------------

Open-ended power cable. Check section 1.1 for the ODU pinout.

ODU Pin#	Pin Name	Wire Color
1	Ground	Black
2	Power1_In	Green
3	Power2_In	White
4	Reserved	Brown
5	Vantenna	Blue



For proper operation, the brown wire (pin#4) must be tied to ground (i.e. to the black wire).

Cable Name: CBL*_HDC_USB	Part #: 201043
--------------------------	----------------

USB cable to be connected to I/O I.

Cable Name: CBL*_HDC_COM	Part #: 201042
--------------------------	----------------

COM1/COM2 to PC (DSUB9-female). This cable can be connected to either I/O I or I/O II, corresponding to COM1 and COM2 respectively. The GND (pin 5), Tx (pin 3) and Rx (pin 2) of the 9-pin DSUB9 connector are connected to respectively pins 1, 2 and 3 of the 16-pin ODU connector. Other pins are not connected.

Cable Name: CBL*_HDC_COM1_USB_GPIO	Part #: 201214
------------------------------------	----------------

COM and USB with GPIO. This cable must be connected to I/O I and gives access to COM1 (DSUB9-female) and USB. RTS/CTS handshaking is not supported on COM1.

Next to the serial and USB connectors, this cable features the following open-ended wires (check section 1.1 for the I/O I ODU pinout):

ODU Pin#	Pin Name (I/O I)	Wire Color
7	nRST_In	Green
12	Ground	Black
13	GPLED	Purple
14	PVTLED	Brown
15	TRACKLED	Yellow
16	PowerOut	Red

Cable Name: CBL*_HDC_COM2_COM3_GPIO	Part #: 201213
-------------------------------------	----------------

Dual COM cable with GPIO. This cable must be connected to I/O II and gives access to COM2 and COM3. RTS/CTS handshaking is only available on COM3.

Next to the two DSUB9 connectors, this cable features the following open-ended wires (check section 1.1 for the I/O II ODU pinout):

ODU Pin#	Pin Name (I/O II)	Wire Color
4	EventA	Red
5	EventB	Purple
6	Reserved	Green
12	Ground	Black
15	xPPS_Out	Brown



Do not leave the red, purple and green wires floating. Tie them to ground if not used. This is to avoid crosstalk effects that could lead to spurious level transitions on the EventA and EventB inputs.

Cable Name: CBL*_HDC_COM2_COM3_GPIZ	Part #: 201236
-------------------------------------	----------------

Dual COM cable with GPIO. This cable must be connected to I/O II and gives access to COM2 and COM3 (RTS/CTS not supported).

Next to the two DSUB9 connectors, this cable features the following open-ended wires (check section 1.1 for the I/O II ODU pinout):

ODU Pin#	Pin Name (I/O II)	Wire Color
4	EventA	Blue
5	EventB	White/Blue
6	Reserved	Green
7	Button	White/Green
9	COM3_CTS	White/Orange
12	Ground	Brown
15	xPPS_Out	Orange

The white/green (Button) or white/orange (COM3\_CTS) wires can be used as ZUPT (zero-velocity) indicators. See also the command **setExtZUPTSource**.



Do not leave the blue, white/blue and green wires floating. Tie them to ground if not used. This is to avoid crosstalk effects that could lead to spurious level transitions on the EventA and EventB inputs.

Cable Name: CBL\*\_HDC\_OE

Part #: 201044

This open-ended cable can be connected to either I/O I or I/O II. Check section 1.1 for the ODU pinout.

Pin#	Pin Name (I/O I)	Pin Name (I/O II)	Wire Color
1	Ground	Ground	Brown/Red
2	COM1_RX	COM2_RX	Orange
3	COM1_TX	COM2_TX	Red
4	USB_D+	EventA	Green
5	USB_D-	EventB	Yellow
6	USB_Vbus	Reserved	Blue
7	nRST_In	Button	Grey
12	Ground	Ground	Brown/Blue
13	GPLED	nRST_Out	White/Black
14	PVTLED	Reserved	Black
15	TRACKLED	xPPS_Out	Brown
16	PowerOut	PowerOut	White/Yellow



When connecting this cable to the I/OII connector, do not leave the green and yellow wires floating. Tie them to ground if not used. This is to avoid crosstalk effects that could lead to spurious level transitions on the EventA and EventB inputs.

Cable Name: CBL\*\_HDC\_ETH\_MS

Part #: 201238

AsteRx2eL\_HDC only. Ethernet to hub/switch (straight) (RJ45) to be connected to I/O I.

Cable Name: CBL\*\_HDC\_ETH\_MX

Part #: 201237

AsteRx2eL\_HDC only. Ethernet to PC (crossed) (RJ45) to be connected to I/O I.

Cable Name: CBL*_HDC_COM_IMU	Part #: 201083
Cable Name: CBL*_HDC_COM_IMU_XL	Part #: 201101

AsteRx2i\_HDC only. These cables connect the AsteRx2i\_HDC with an MTi IMU sensor. The “\_XL” version of the cable is longer than the other (5m vs. 1.8m).

Plugging this cable into I/O I connects the IMU with the receiver’s COM1 port. You will need to issue the command **setDataInOut,COM1,MTi** to tell the receiver to use COM1 to communicate with the IMU (see the “How To…” section of the Firmware User Manual for details).

Plugging this cable into I/O II connects the IMU with the receiver’s COM2 port. You will need to issue the command **setDataInOut,COM2,MTi** to tell the receiver to use COM2 to communicate with the IMU.

Cable Name: CBL*_HDC_COM2_COM3_GPIZ	Part #: 201236
-------------------------------------	----------------

AsteRx2i\_HDC only. Dual COM cable with GPIZ. This cable must be connected to I/O II and gives access to COM2 and COM3. Only the GND, Tx and Rx pins of the DSUB9 connectors are wired. RTS/CTS handshaking is not supported.

Next to the two DSUB9 connectors, this cable features the following open-ended wires (check section 1.1 for the I/O II ODU pinout):

ODU Pin#	Color
4	Red
5	Purple
6	Green
9	Yellow
12	Black
15	Brown

The yellow wire is typically used as ZUPT indicator when the COM3CTS line is configured as ZUPT source with the command **setZUPTSource**.



Do not leave the red, purple and green wires floating. Tie them to ground if not used. This is to avoid crosstalk effects that could lead to spurious level transitions on the EventA and EventB inputs.

### 1.3 Stand-By Mode

The receiver can be put in stand-by mode by entering the command “**exePowerMode, standby**” (see Command Line Interface Reference Guide).

After having requested to enter stand-by mode, it takes up to 0.5 seconds for the receiver to actually enter low-power state. This time is required to unmount the SD memory card and stop all software activities.

Putting the receiver in stand-by mode is mandatory before shutting down the power supply if internal logging is active.

## 1.4 SD Memory Card Usage

The receiver incorporates a SD memory card for internal logging. Refer to the “How-to...” section of the Firmware User Manual to learn how to use this feature.



Before unplugging the power connector or resetting the receiver, it is needed to put the receiver in stand-by mode and to wait at least 0.5 seconds for the SD card to be cleanly unmounted (see also section 1.3). Failing to do so can lead to file corruption.

## 1.5 Applicable Software Package

The AsteRx2e\_HDC and AsteRx2i\_HDC are compatible with Septentrio’s SSRC1 Software Packages.

The AsteRx2eL\_HDC is compatible with Septentrio’s SSRC3 Software Packages.

## 1.6 Hardware Specifications

### 1.6.1 Power Consumption

Nominal operation:

AsteRx2e_HDC:	3.1W
AsteRx2i_HDC:	3.1W without MTi IMU connected, 3.6W with MTi connected
AsteRx2eL_HDC:	4.3W

Stand-by mode : 0.55 W

### 1.6.2 Environmental

Temperature Range: -40 to +60 °C (operational)  
-55 to +85 °C (storage)

Ingress Protection: IP65

Shock: MIL-STD-810F, 516.5

Vibration: MIL-STD-810F, 514.5

## 2 AsteRx2eH\_PRO



### 2.1 Rear Panel Connectors

The rear panel features five connectors.



#### 2.1.1 MAIN and AUX (TNC)

These are the main and auxiliary antenna connectors. Connect active GNSS antennas to these connectors. The gain at the connectors (antenna gain minus cable losses) must be in the range 15 to 50dB.

By default, the receiver provides a 5V DC supply on the MAIN and AUX connectors to feed the antenna. Other voltages can be imposed through pin ANT\_EXT of the IN connector on the front panel (see section 2.2.6). The maximum current for each antenna is 200mA.

**!** Never inject a DC voltage into the MAIN connector as it may damage the receiver. For instance, when using a splitter to distribute the antenna signal to several receivers, make sure that no more than one output of the splitter passes DC. Use DC-blocks otherwise.



## 2.1.2 PPS OUT (BNC)

xPPS output (5V, output impedance 50ohms). The characteristics of the xPPS output signal are specified by the **setPPSPParameters** command. The pulse duration is 2ms.

## 2.1.3 REF IN (BNC)

Use this connector to provide the receiver with an external 10 MHz frequency reference, to be used instead of the internal oscillator. The reference signal must be sinusoidal with a peak-to-peak amplitude (unloaded) ranging from 0.5V to 2V (-8dBm to +4dBm in a 50Ω load).

Connecting or disconnecting the external 10 MHz reference must be done with the receiver switched off. The receiver checks the presence of the external frequency reference during its start-up phase. If a valid reference signal is found, the receiver clock is automatically locked to this reference. Otherwise the internal oscillator is used as frequency reference.

If the 10 MHz reference is removed during operation, the receiver will stop.

## 2.1.4 REF OUT (BNC)

This connector provides a 10 MHz output signal synchronized with the frequency reference used by the receiver (be it internal or external). It is a sinusoidal signal with unloaded peak-to-peak amplitude of 1.1V, and output impedance of 50Ohms.

## 2.2 Front Panel Connectors

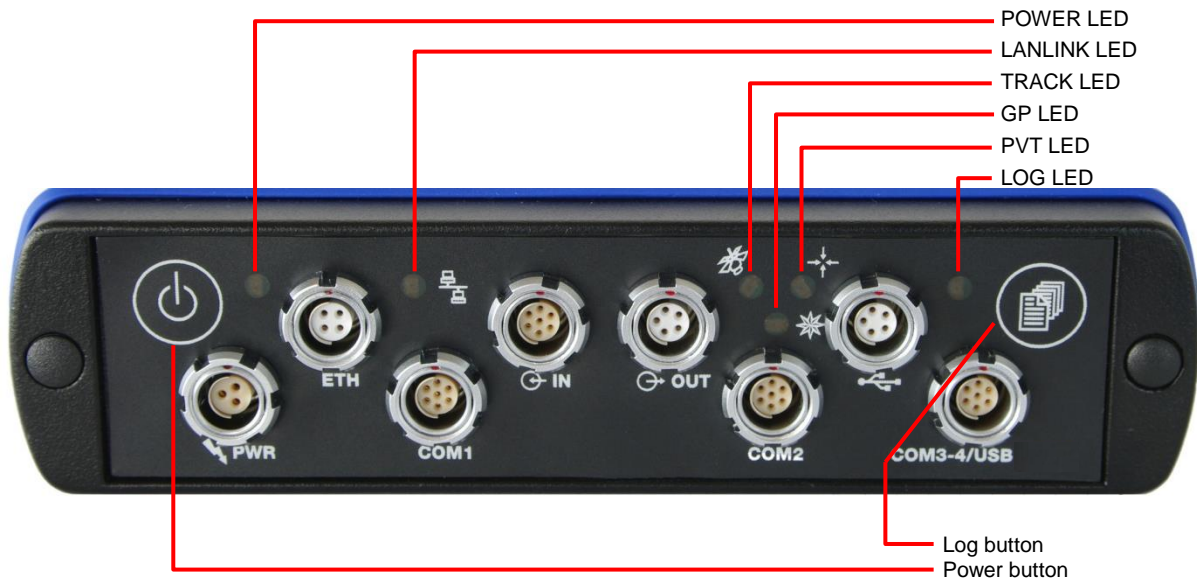

The front panel features 8 ODU connectors, which are described in the following sections. These connectors are all of type ODU MINI SNAP Series F. The pinout of the female connectors and the ODU part number of the corresponding male connectors is shown below.

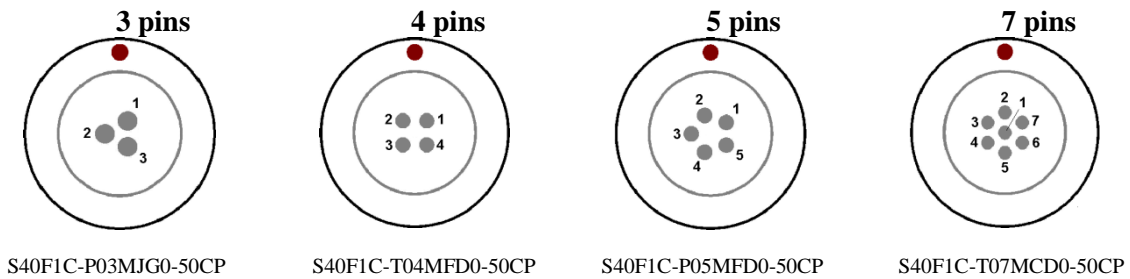

### 2.2.1 COM1

This 7-pin connector provides access to the first serial port (COM1).

Pin #	Description
1	Not connected
2	Signal ground (GND)
3	Not connected
4	Not connected
5	Receive Data (RXD – input to the receiver )
6	Transmit Data (TXD – output from the receiver)
7	Not connected

The receiver behaves as Data Terminal Equipment (DTE). For direct connection to a terminal or a PC, a null-modem cable is needed.

## 2.2.2 COM2

This 7-pin connector provides access to the second serial port (COM2).

Pin #	Description
1	+5V DC output
2	Signal ground (GND)
3	Clear To Send (CTS – input)
4	Request To Send (RTS – output)
5	Receive Data (RXD – input)
6	Transmit Data (TXD – output)
7	Not connected

The receiver behaves as Data Terminal Equipment (DTE). For direct connection to a terminal or a PC, a null-modem cable is needed.

Pin#1 provides a 5V DC voltage, e.g. to allow feeding a Bluetooth™ device.

## 2.2.3 COM3-4/USB

This 7-pin connector can be configured in two modes:

- COM3 and COM4 mode
- USB mode.

The electrical level at pin#7 defines the operating mode.

### 2.2.3.1 COM3-4 mode

This mode is selected by leaving pin#7 unconnected.

Pin #	Description
1	Not connected
2	GND
3	COM4 RX
4	COM4 TX
5	COM3 RX
6	COM3 TX
7	Leave unconnected

### 2.2.3.2 USB mode

This mode is selected by applying 5V DC to pin#7.

Pin #	Description
1	Not connected
2	GND
3	USB D-
4	Reserved
5	USB D+
6	Reserved
7	USB Vbus

## 2.2.4 ETH

Pin #	Description
1	TxD+
2	TxD-
3	RxD+
4	RxD-

## 2.2.5 OUT

Pin #	Description
1	Reserved
2	GND
3	GP1 output, 3.3V. Use the command <b>setGPIOFunctionality</b> to set the level of this pin.
4	GP2 output, 3.3V. Use the command <b>setGPIOFunctionality</b> to set the level of this pin.
5	nRST_OUT. Open-collector output, driven low when the receiver is resetting.

## 2.2.6 IN

Pin #	Description
1	Reserved, leave unconnected.
2	GND
3	Reserved, leave unconnected.
4	nRST_IN. Driving this pin low resets the receiver. Internally pulled-up. Debouncing and deglitching is foreseen.
5	EVENTA, 3.3V CMOS, 5V tolerant, 100kΩ pull down resistor. This is the first digital input for external event timing, see Firmware User Manual for operation.
6	EVENTB, 3.3V CMOS, 5V tolerant, 100kΩ pull down resistor. This is the second digital input for external event timing, see Firmware User Manual for operation.
7	<p>ANT_EXT, external antenna power. Can be used to apply an external supply voltage to the antenna. The voltage applied to ANT_EXT (<math>V_{ANT}</math>) determines the voltage source on the MAIN and AUX1 connectors, as follows:</p> <ul style="list-style-type: none"> <li>if <math>V_{ANT} &lt; 2.0V</math> or ANT_EXT left open, the antenna is powered by the internal 5V supply;</li> <li>if <math>3.0V &lt; V_{ANT} &lt; 4.0V</math>, there is no power provided to the MAIN connector;</li> <li>if <math>5.0V &lt; V_{ANT} &lt; 12.0V</math>, the antenna power supply is taken from ANT_EXT.</li> </ul> <p><b>Warning:</b> Exceeding 12.0V for <math>V_{ANT}</math>, or drawing more than 200mA from the antenna connector can permanently damage the receiver.</p>

## 2.2.7

Pin #	Description
1	Reserved
2	Reserved
3	Reserved
4	Reserved
5	Reserved

## 2.2.8 PWR

Pin #	Description
1	Power: 9 to 30V DC
2	ON/OFF. When this pin is tied to pin#1, the receiver is always on, regardless of the state of the on/off button.
3	GND

If you are using a different power adaptor than the one provided by Septentrio, make sure that it can sustain a current of 1.5A.

## 2.3 Log Button

The log button toggles internal logging on and off. See the “*HowTo...*” section of the Firmware User Manual for details.

## 2.4 Power Button

The power button retains its state through a power outage. If the receiver is on when the power is cut off, it will automatically restart when the power comes back. If it is off, it will remain off after the power comes back.

## 2.5 Status LEDs

The behaviour of the LOGLED, PVTLED, GPLED and TRACKLED is described in Appendix B.

## 2.6 Cables

Cable Name: CBLe_COM_1,8	Part #: 200416
--------------------------	----------------

COM1/COM2 to PC (DSUB9-female). To be connected to either the COM1 or COM2 connector. Note that RTS/CTS lines are only available when connected to COM2.

Cable Name: CBLe_COM_DUO_7	Part #: 201204
----------------------------	----------------

Dual COM3 and COM4 to PC (DSUB9-female). To be connected to the COM3-4/USB connector. Note that RTS/CTS is not supported on these ports.

Cable Name: CBL <sub>e</sub> _GPO_OE_5	Part #: 201203
--	----------------

Open-ended cable to be used with the OUT connector (see pinout in section 2.2.5).

Pin#	Wire Color
1	Blue
2	Blue/Black
3	Orange
4	Green
5	Brown

Cable Name: CBL <sub>e</sub> _GPI_OE	Part #: 200419
--------------------------------------	----------------

Open-ended cable to be used with the IN connector (see pinout in section 2.2.6).

Pin#	Wire Color
1	Orange
2	Green
3	Yellow
4	Black
5	Red
6	Purple
7	Brown



Do not leave the red and purple wires floating. Tie them to ground if not used. This is to avoid crosstalk effects that could lead to spurious level transitions on the EventA and EventB input pins.

Cable Name: CBL <sub>e</sub> _USB	Part #: 201202
-----------------------------------	----------------

USB cable to be connected to the COM3-4/USB connector.

Cable Name: CBL <sub>e</sub> _ETH_MS	Part #: 200418
--------------------------------------	----------------

Ethernet to hub/switch (straight) (RJ45). To be connected to the ETH connector.

Cable Name: CBL <sub>e</sub> _ETH_MX	Part #: 200417
--------------------------------------	----------------

Ethernet to PC (crossed) (RJ45). To be connected to the ETH connector.

Cable Name: CBL<sub>e</sub>\_PWR\_OE

Part #: 200422

Open ended cable for the PWR connector (see pinout in section 2.2.8).

Pin#	Wire Color
1	Blue and green (these two wires are both connected to Pin#1)
2	Red
3	Black and Purple (these two wires are both connected to Pin#3)

## 2.7 Internal Logging on SD Memory Card

The receiver incorporates a SD memory card for internal logging. Refer to the “*How-to...*” section of the Firmware User Manual to learn how to use this feature.

To prevent data corruption, logging is protected against accidental power outages. There is no need to unmount the SD memory card before switching off the receiver.

## 2.8 Applicable Software Package

The AsteRx2eH\_PRO is compatible with Septentrio’s SSRC2 Software Packages.

## 2.9 Hardware Specifications

Power consumption:	5W
Size:	234 x 140 x 37 mm
Temperature Range:	-40 to +60 °C (operational) -55 to +85 °C (storage)
Ingress Protection:	IP65
Shock:	MIL-STD-810F, 516.5
Vibration:	MIL-STD-810F, 514.5

## 3 AsteRx2e\_OEM & AsteRx2i\_OEM

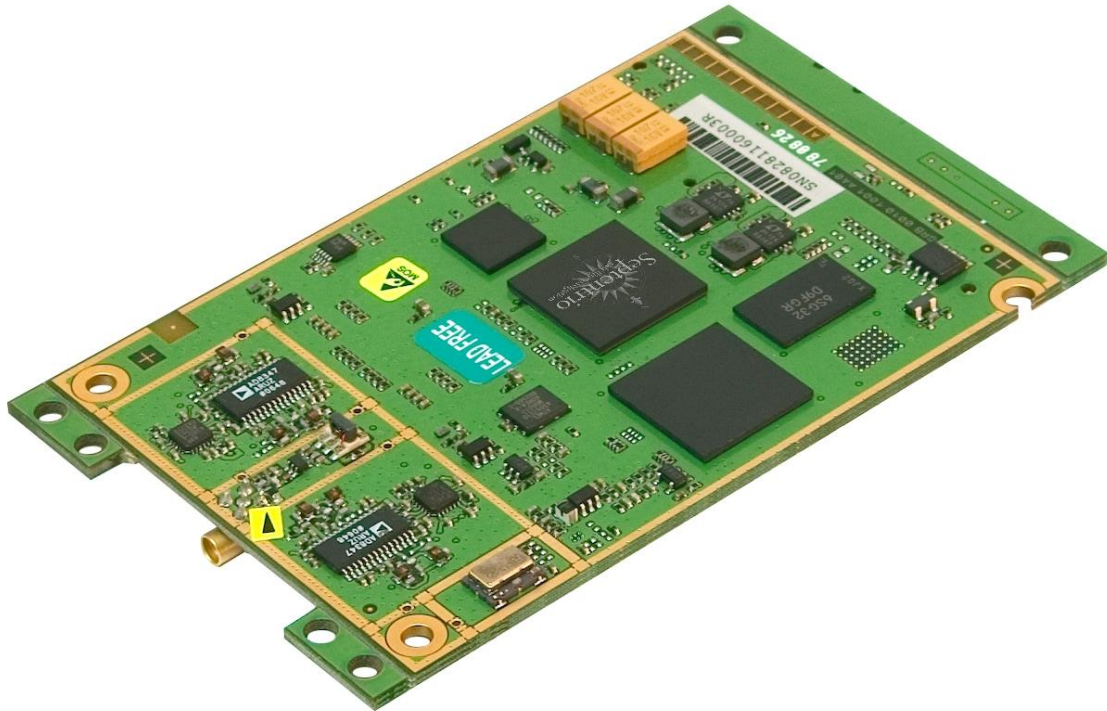

### 3.1 Mechanical Drawings

Weight: 60g

Height:

- 80-pin connector: 4.57mm
- MMCX connector: 3.70mm
- Bottom side components (excluding MMCX and 80-pin connector): max 1.80mm
- Top side components: max 4.06mm
- PCB width: max 1.65mm

All mounting holes have an inner diameter of 3.2mm (intended for M3 screws).

The drawings below show the dimensions of the printed-circuit board. The parts painted yellow only contain mounting holes and can be cut away.



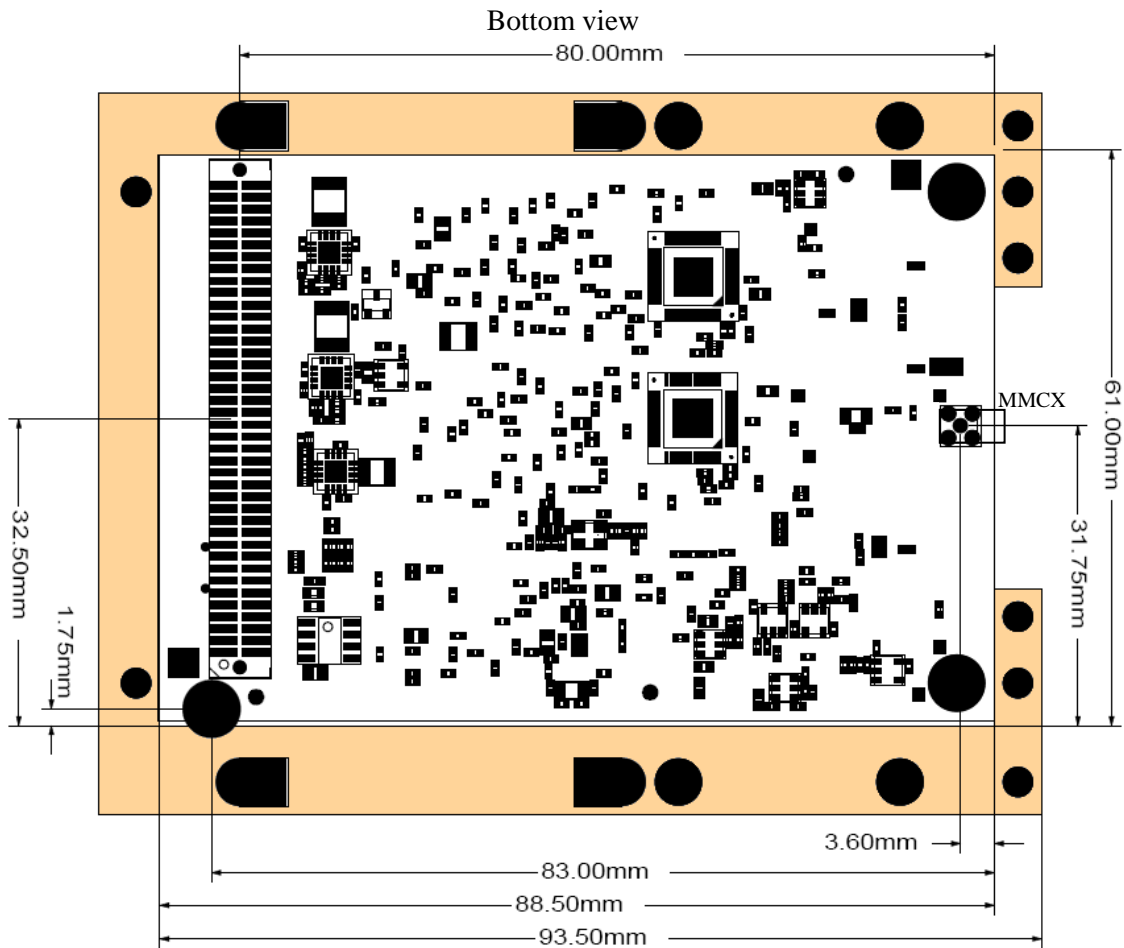
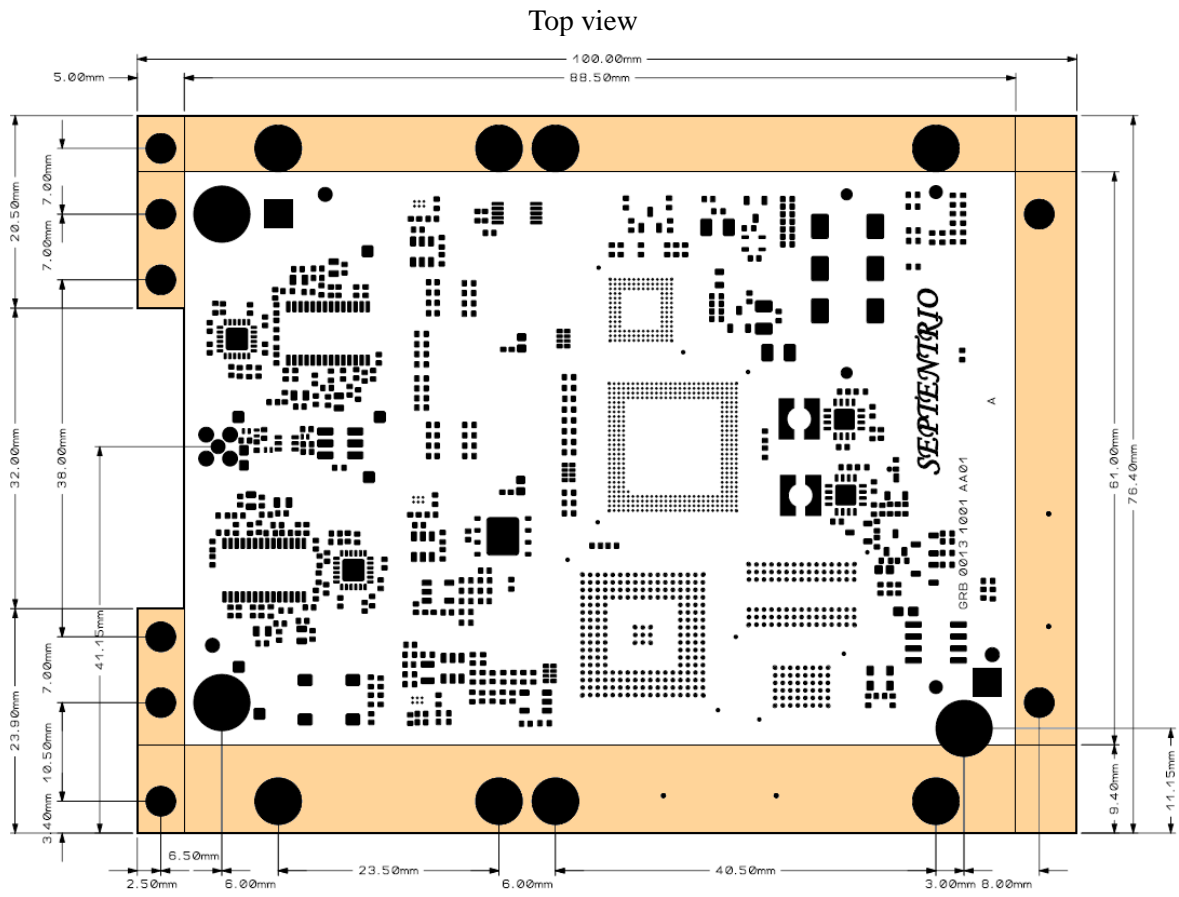

Pin#1 of the 80-pin connector is at the bottom left (marked by the light-gray circle) in the above drawing. Pin#2 is at the bottom right.

The right-angle MMCX connector is mounted on the bottom side of the board and protrudes 1.2mm beyond the edge of the PCB.

## 3.2 Electrical Specifications

See Appendix A.

## 3.3 Applicable Software Package

The AsteRx2e\_OEM and AsteRx2i\_OEM are compatible with Septentrio's SSRC1 Software Packages.

## 3.4 Hardware Specifications

### 3.4.1 Power Consumption

Nominal operation: 1.85 W

Stand-by mode : 15 mW

Max in-rush current: 800mA

### 3.4.2 Temperature Range

Operational: -40 to +85 °C

Storage: -55 to +85 °C

## 3.5 IMU Cable (AsteRx2i\_OEM only)

Cable Name: CBL*_HDC_COM_IMU_OE	Part#: 201082
---------------------------------	---------------

The 7-pin ODU connector must be connected to the Xsens MTi IMU.

The 7-pin crimp housing connector is of type Molex 51021-0700 and mates with Molex header 53047-0710.

ODU Pin#	Color	Function	Connection tip
1	White	VCC	This pin supplies power to the MTi sensor. Supply voltage: 5V Average power consumption: 350mW
2	Brown	GND	
3	Green	Reserved	
4	Yellow	TX (MTi), RS232	To be connected to the receive line of either COM1, COM2 or COM3 of the OEM receiver. Use a transceiver to connect to TTL-level COM ports.
5	Grey	RX (MTi), RS232	To be connected to the transmit line of either COM1, COM2 or COM3 of the OEM receiver. Use a transceiver to connect to TTL-level COM ports.
6	Pink	Reserved	
7	Blue	Reserved	

## 4 AsteRx2eH\_OEM

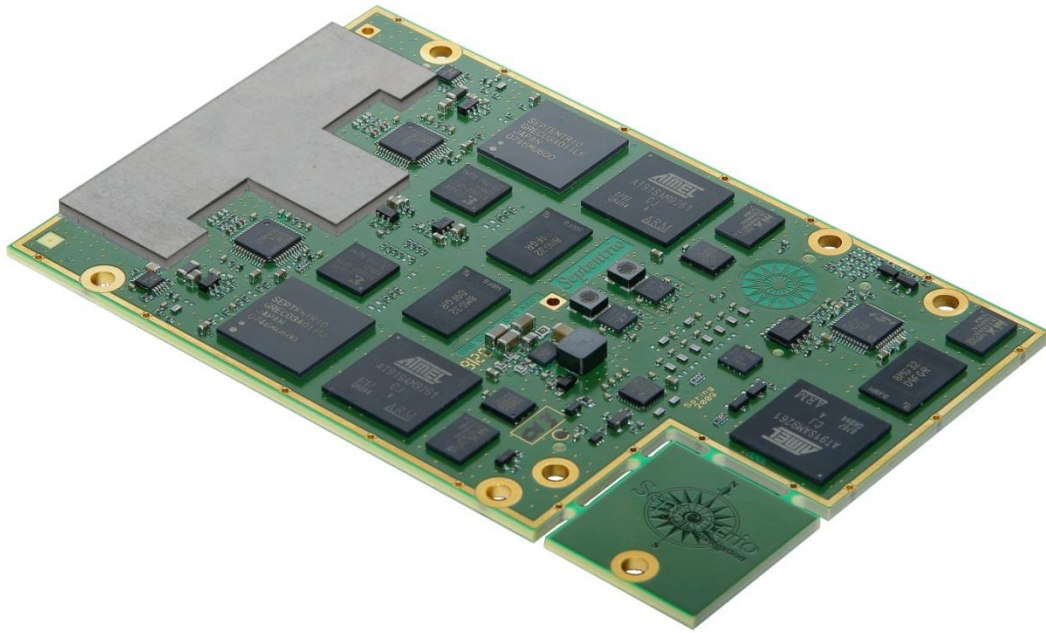

### 4.1 Mechanical Drawings

Weight: 90g

Height:

- 80-pin connector: 4.57mm
- MMCX connectors: 3.70mm
- Bottom side components (excluding MMCX and 80-pin connectors): max 1.80mm
- Top side components: max 4.06mm
- PCB width: 2.0mm

All mounting holes have an inner diameter of 3.2mm (intended for M3 screws).

The drawings below show the dimensions of the printed-circuit board.

# Top View

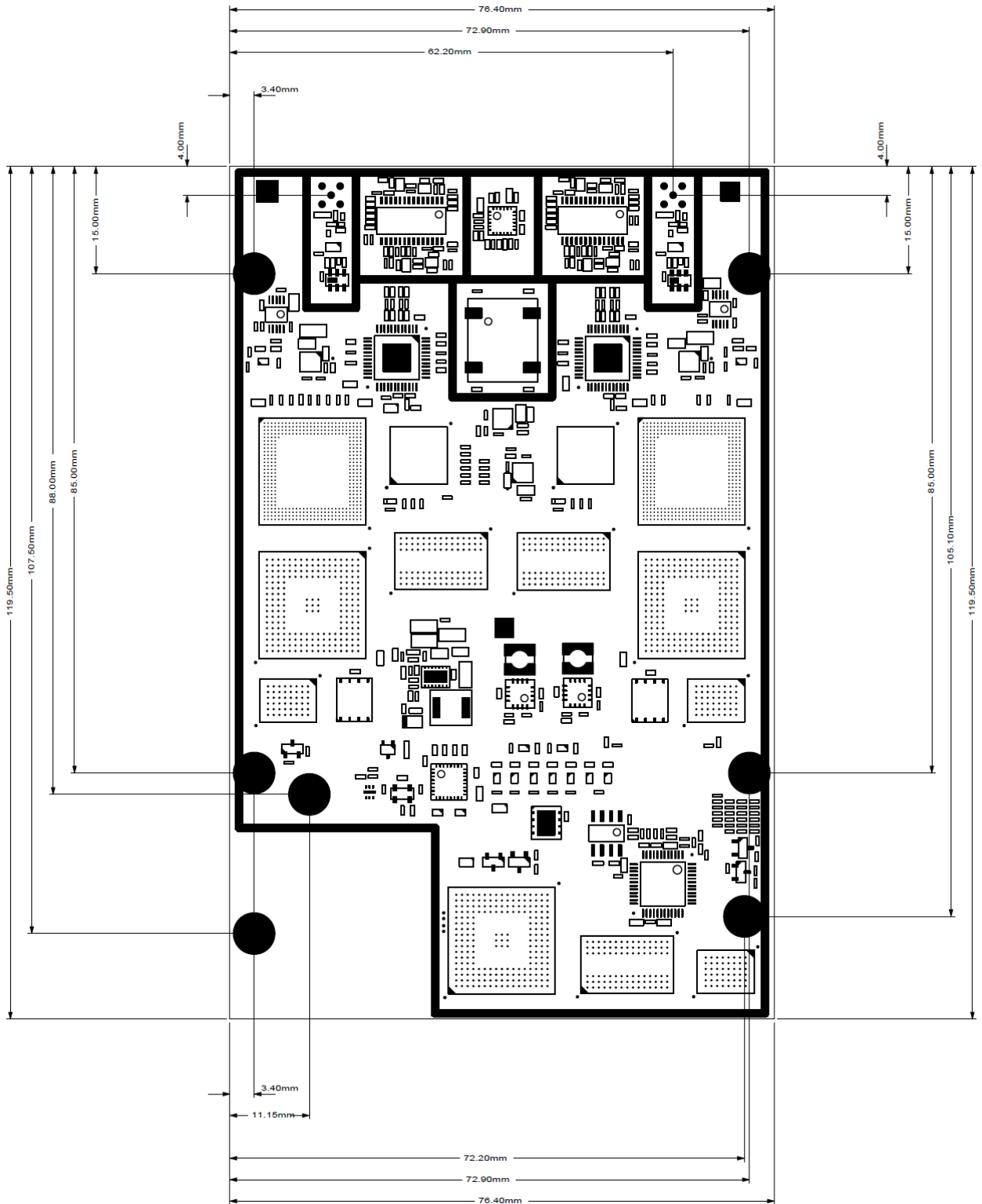

## Bottom View

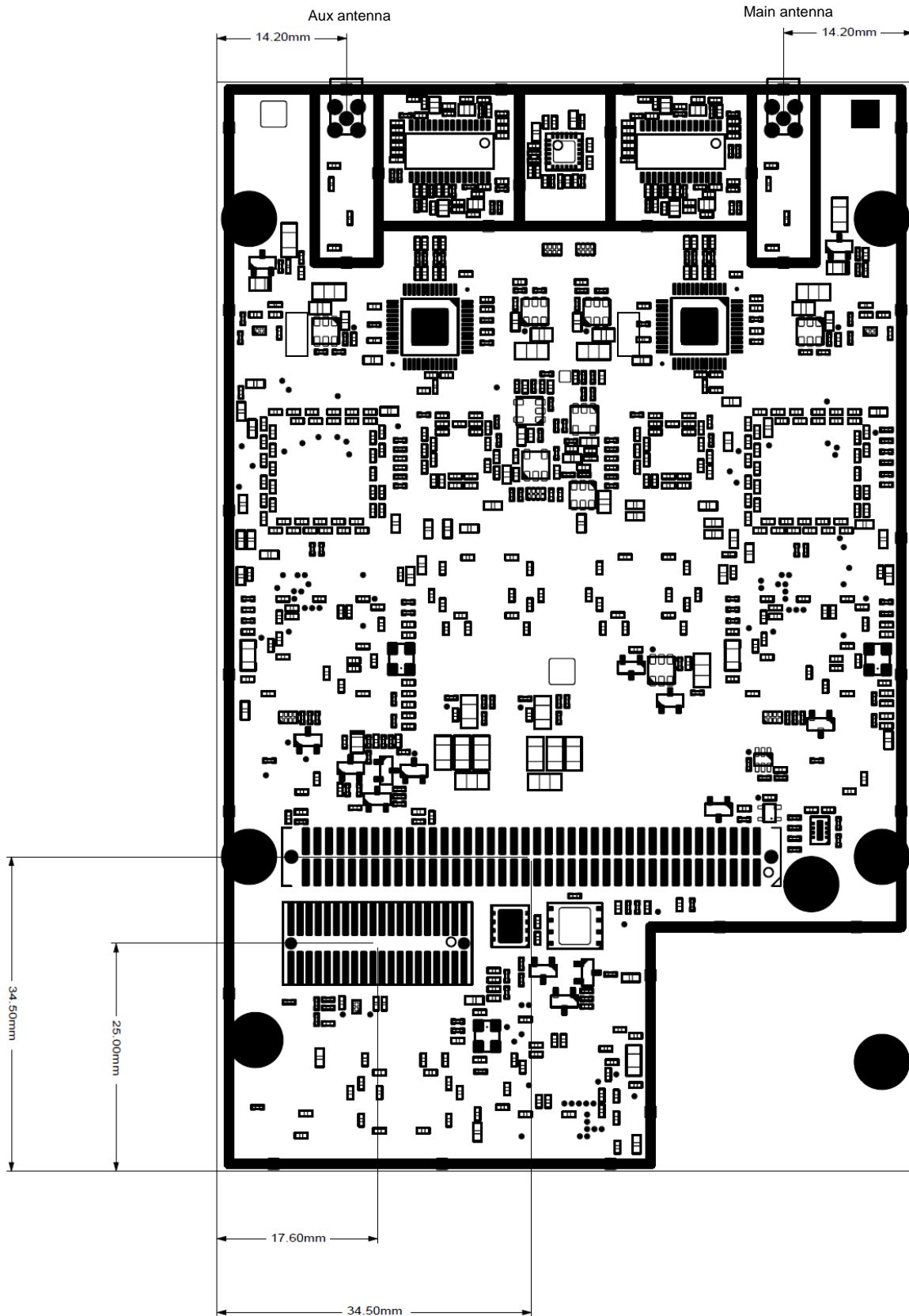

Pin#1 of the 80-pin connector is at the bottom right (marked by the light-gray circle) in the above drawing. Pin#2 is above pin#1. Pin#3 is at the right of pin#1 and so on.

The right-angle MMCX connectors are mounted on the bottom side of the board and protrude 1mm beyond the edge of the PCB.

## 4.2 Electrical Specifications

See Appendix A.

## 4.3 Applicable Software Package

The AsteRx2eH\_OEM is compatible with Septentrio's SSRC2 Software Packages.

## 4.4 Hardware Specifications

### 4.4.1 Power Consumption

Nominal operation: 4.6 W at  $V_{in} = 3.3V$ ;  
4.8 W at  $V_{in} = 5.0V$ .

Stand-by mode : 50 mW

Max in-rush current: 1.7A at  $V_{in} = 3.3V$   
1.3A at  $V_{in} = 5.0V$

### 4.4.2 Temperature Range

Operational: -40 to +85 °C  
Storage: -55 to +85 °C

## 5 AsteRx2eL\_OEM



### 5.1 Mechanical Drawings

Weight: 76g

Height:

- Bottom-side components:
  - 80-pin connector: 4.57mm
  - MMCX connector: 3.70mm
  - Bottom-side shield: max 4.00mm
- Top-side shield height: max 4.40mm
- PCB width: max 1.65mm

All mounting holes have an inner diameter of 3.2mm (intended for M3 screws).

The drawings below show the dimensions of the printed-circuit board. The parts painted yellow only contain mounting holes and can be cut away.

Top View

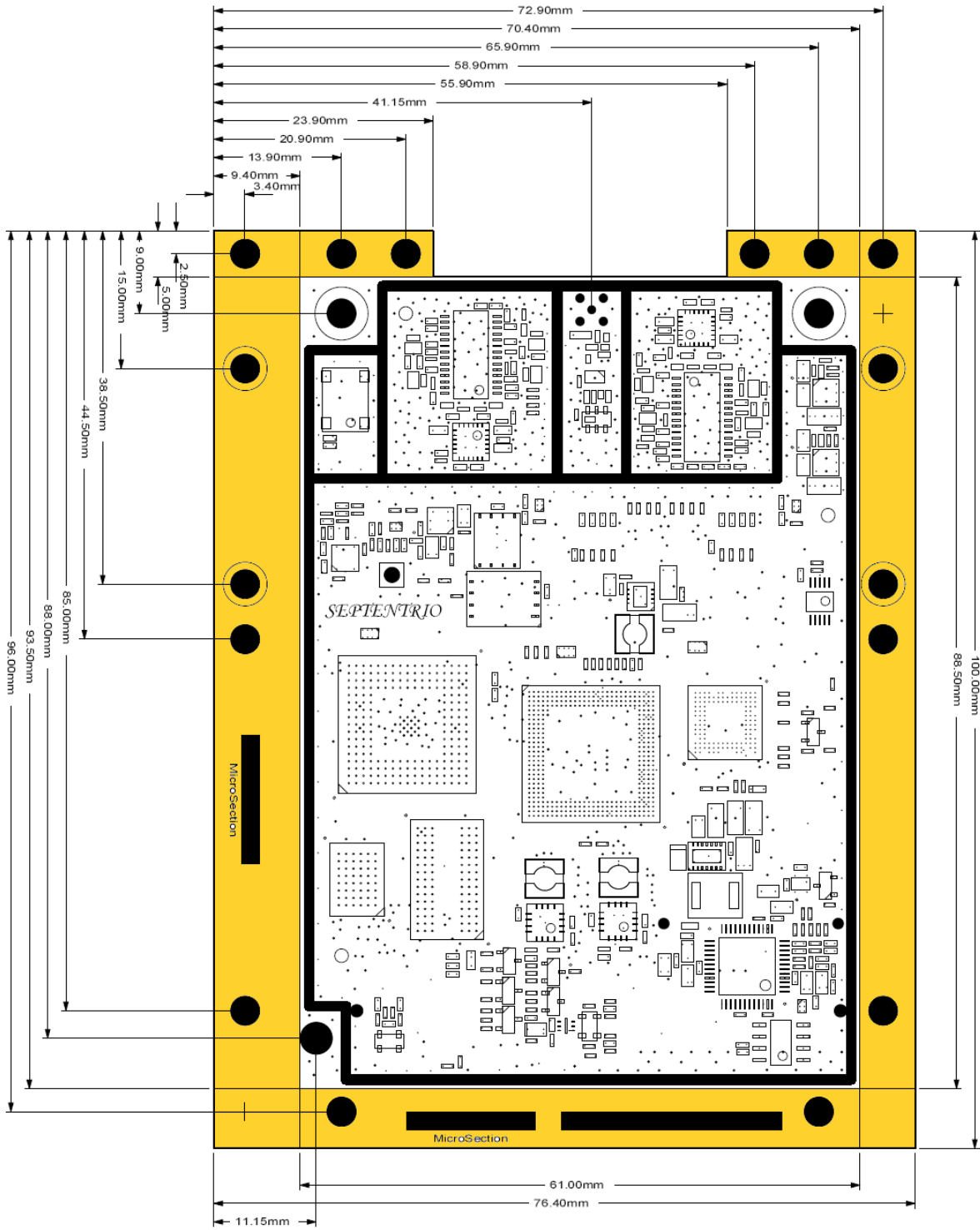



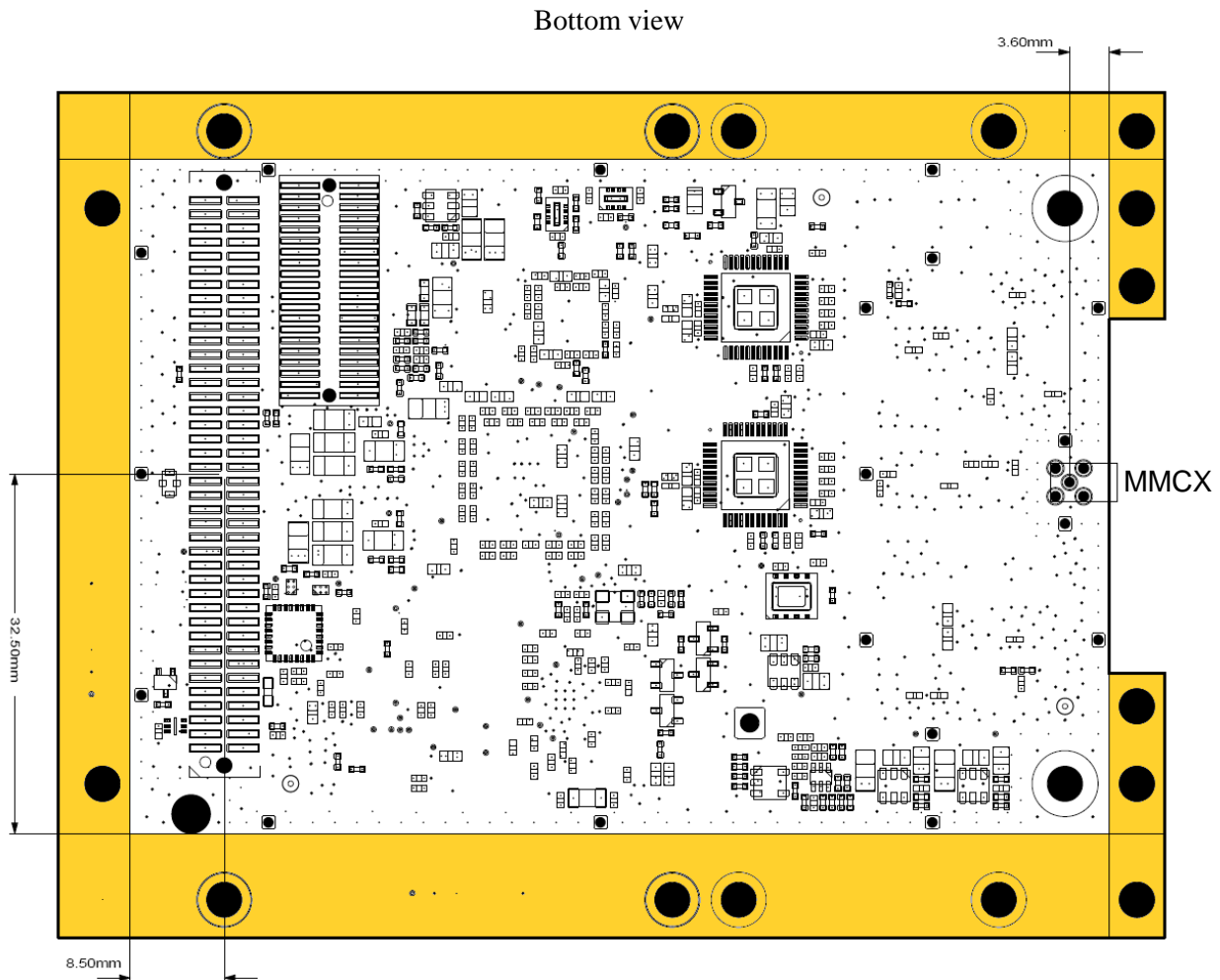

Pin#1 of the 80-pin connector is at the bottom left (marked by the light-gray circle) in the above drawing. Pin#2 is at the bottom right.

The right-angle MMCX connector is mounted on the bottom side of the board and protrudes 1.2mm beyond the edge of the PCB.

## 5.2 Electrical Specifications

See Appendix A.

## 5.3 Applicable Software Package

The AsteRx2eL\_OEM is compatible with Septentrio's SSRC3 Software Packages.

## 5.4 Hardware Specifications

### 5.4.1 Power Consumption

Nominal operation: 3 W  
Stand-by mode : 15 mW

Max in-rush current: 1.3A at  $V_{in} = 3.3V$   
0.9A at  $V_{in} = 5.0V$

## 5.4.2 Temperature Range

Operational:	-40 to +85 °C
Storage:	-55 to +85 °C

# Appendix A OEM Receivers Electrical Specifications

## A.1 Antenna Connector

Type: MMCX, right angle  
 DC voltage: As provided by pin#14 of the 80-pin connector  
 Gain range: 15 dB to 50 dB (antenna gain minus cable losses)

 Never inject a DC voltage into the antenna connector as it may damage the receiver. For instance, when using a splitter to distribute the antenna signal to several receivers, make sure that no more than one output of the splitter passes DC. Use DC-blocks otherwise.

## A.2 80-pin Connector

Connector type: SFM-140-02-SM-D

Conventions:

- Pin Type: I=Input, O=Output, P=Power line, LVTTTL=3V3 Low Voltage TTL.
- LVTTTL means  $V_{IL} \leq 0.8V$ ,  $V_{IH} \geq 2.0V$ ,  $V_{OL} \leq 0.4V$ ,  $V_{OH} \geq 2.4V$ .

 To avoid board damage, all input pins (type “I”) must be driven low or left floating (source impedance  $\geq 10k\Omega$ ) when the receiver is in sleep or power-off mode, with the exception of pins #8 (nPWR\_TOGGLE), #10 (nRST\_IN), #76 (RS232\_RX1) and #80 (RS232\_RX2). Sleep/off mode can be detected by the fact that the voltage at pin#29 (VCC\_3V3\_OUT) is zero. Pin#29 can be used as an “enable” for the drivers driving the input pins.

 When pull-up resistors are needed,  $10k\Omega$  is recommended. Always pull up to 3.3V, even when supplying the receiver with 5-V DC at the Vin pins (not all receiver models allow 5-V DC supply, see next warning). It is safe to connect the pull-up resistors to pin#29 (VCC\_3V3\_OUT).

 The supported voltage range at the Vin pins depends on the receiver model:

Receiver Model	Vin range (pins#15 and #16)
AsteRx2e_OEM	$3.3V < V_{in} < 3.38V$
AsteRx2i_OEM	$3.3V < V_{in} < 3.38V$
AsteRx2eL_OEM	$3.0V < V_{in} < 5.5V$
AsteRx2eH_OEM	$3.0V < V_{in} < 5.5V$

Pin#	Name	Type	Level	Description	Connection Tips
2	Gnd	Gnd	0	Ground.	All ground pins must be connected.
4	USB_Vbus	P	4.35V ≤ V <sub>high</sub> ≤ 5.25V	USB Power. Cannot be used to power the receiver.	Leave unconnected if USB not used.
6	Gnd	Gnd	0	Ground.	All ground pins must be connected.
8	nPWR_TOGGLE	I	LVTTL	Power toggling input, active negative. Applying a negative pulse to this pin orders the receiver to enter stand-by mode if it was operating, and to start operation if it was in stand-by mode (see section A.4).	Leave unconnected if not used (there is an internal pull-up). For proper operation, the duration of the negative pulse must be at least 200ms and no longer than 5s.
10	nRST_IN	I	LVTTL	Reset input, active negative. Receiver resets when driven low for at least 1ms.	Leave unconnected if not used.
12	Reserved			Reserved for future use	Leave unconnected.
14	Vantenna	P	3.15V < Vant < 12V	Antenna supply, max current per antenna 200mA. The voltage provided on this pin is transferred to the central conductor of the antenna MMCX connector(s).	
16	Vin	P	see warning above	Main power supply input	Both Vin pins (pin#16 and pin#15) must be tied together.
18	Gnd	Gnd	0	Ground.	All ground pins must be connected.
20	SCOM_TX1	O	LVTTL	Serial COM 1 transmit line (inactive state is high)	Leave unconnected if not used.
22	SCOM_TX2	O	LVTTL	Serial COM 2 transmit line (inactive state is high)	Leave unconnected if not used.
24	SCOM_TX3	O	LVTTL	Serial COM 3 transmit line (inactive state is high)	Leave unconnected if not used.
26	SCOM_TX4	O	LVTTL	Serial COM 4 transmit line (inactive state is high)	Leave unconnected if not used.
28	Gnd	Gnd	0	Ground.	All ground pins must be connected.
30	Reserved			Reserved for future use	Leave unconnected.
32	Gnd	Gnd	0	Ground.	All ground pins must be connected.
34	EVENT_A	I	LVTTL	Event A input (see Firmware User Manual for operation instructions)	Tie to ground if not used.
36	Gnd	Gnd	0	Ground.	All ground pins must be connected.
38	PPSout	O	LVTTL	PPS output. See Firmware User Manual for operation instructions. Pulse duration: 2ms.	Leave unconnected if not used.
40	Gnd	Gnd	0	Ground.	All ground pins must be connected.
42	Reserved			Reserved for future use	Leave unconnected.
44	Button	I	LVTTL	Input can be connected to a push button, typically used to enable and disable internal logging. High to low transitions are detected as "button pressed" events.	Debouncing must be done externally (no debouncing circuit on board). External pull up to 3.3V is necessary. Pull up to 3.3V if not used.
46	SCOM_RTS2	O	LVTTL	Serial COM 2 RTS line	Leave unconnected if not used.
48	SCOM_RTS3	O	LVTTL	Serial COM 3 RTS line	Leave unconnected if not used.
50	GPLED	O	LVTTL	General-purpose status indicator, see Appendix B.	Leave unconnected if not used. Max output current: 8mA
52	GP3	O	LVTTL	GP3 in <b>setGPIOFunctionality</b> command.	Leave unconnected if not used. Max output current: 8mA
54	GP2	O	LVTTL	GP2 in <b>setGPIOFunctionality</b> command.	Leave unconnected if not used. Max output current: 8mA
56	PVTLED	O	LVTTL	PVT status indicator, see Appendix B.	Leave unconnected if not used. Max output current: 8mA
58	Gnd	Gnd	0	Ground.	All ground pins must be connected.
60	Reserved			Reserved for future use	Leave unconnected.
62	SPI1_MISO	I	LVTTL	μC SPI1 Master In Slave Out. The receiver is the SPI master. Max data rate 25Mbit/s.	Leave unconnected if not used, or connect to SO of a SPI slave device.
64	SPI1_nCS1	O	LVTTL	μC chip select 1. This chip select corresponds to the SD memory card, see section A.6.	Leave unconnected if not used.
66	Reserved			Reserved for future use	Leave unconnected.
68	Gnd	Gnd	0	Ground.	All ground pins must be connected.
70	Reserved			Reserved for future use	Leave unconnected.
72	Reserved			Reserved for future use	Leave unconnected.
74	RS232_TX1	O	RS232	Serial COM 1 transmit line (RS232 level)	Leave unconnected if not used.
76	RS232_RX1	I	RS232	Serial COM 1 receive line (RS232 level)	Leave unconnected if not used. This pin is active only if pin#69 is tied to ground.
78	RS232_TX2	O	RS232	Serial COM 2 transmit line (RS232 level)	Leave unconnected if not used.
80	RS232_RX2	I	RS232	Serial COM 2 receive line (RS232 level)	Leave unconnected if not used. This pin is active only if pin#69 is tied to ground.

Pin#	Name	Type	Level	Description	Connection Tips
1	Gnd	Gnd	0	Ground.	All ground pins must be connected.
3	USB_D-	I/O	USB	USB data signal negative D-.	Leave unconnected if USB not used.
5	USB_D+	I/O	USB	USB data signal positive D+.	Leave unconnected if USB not used.
7	Gnd	Gnd	0	Ground.	All ground pins must be connected.
9	Reserved			Reserved for future use	Leave unconnected.
11	Reserved			Reserved for future use	Leave unconnected.
13	Reserved			Reserved for future use	Leave unconnected.
15	Vin	P	3.0V<Vin<5.5V	Main power supply input.	Both Vin pins (pin#16 and pin#15) must be tied together.
17	Gnd	Gnd	0	Ground.	All ground pins must be connected.
19	SCOM_RX1	I	LVTTL	Serial COM 1 receive line (inactive state is high). Disabled when pin#69 is tied to ground.	Pull up to 3.3V if not used.
21	SCOM_RX2	I	LVTTL	Serial COM 2 receive line (inactive state is high). Disabled when pin#69 is tied to ground.	Pull up to 3.3V if not used.
23	SCOM_RX3	I	LVTTL	Serial COM 3 receive line (inactive state is high)	Pull up to 3.3V if not used.
25	SCOM_RX4	I	LVTTL	Serial COM 4 receive line (inactive state is high).	Pull up to 3.3V if not used.
27	Gnd	Gnd	0	Ground.	All ground pins must be connected.
29	VCC_3V3_OUT	P	3.3V -6% to +4%	3.3V power supply output (10mA max), or 0V if the receiver is in sleep or stand-by mode.	See warning at the beginning of this section.
31	Reserved			Reserved for future use	Leave unconnected.
33	Gnd	Gnd	0	Ground.	All ground pins must be connected
35	EVENT_B	I	LVTTL	Event B input (see Firmware User Manual for operation instructions)	Tie to ground if not used.
37	Gnd	Gnd	0	Ground.	All ground pins must be connected.
39	REF_O	O	LVTTL	10-MHz square wave output from the internal frequency reference.	Tie to pin#43 (REF_I) to use the internal frequency reference, or leave unconnected if an external frequency reference is provided on pin #43. (see also section A.3).
41	Gnd	Gnd	0	Ground.	All ground pins must be connected.
43	REF_I	I	LVTTL	10-MHz square wave frequency reference input.	Tie to pin#39 (REF_O) to use the internal frequency reference, or connect to an external frequency reference. (see also section A.3).
45	SCOM_CTS2	I	LVTTL	Serial COM 2 CTS line	Tie to ground if not used.
47	SCOM_CTS3	I	LVTTL	Serial COM 3 CTS line	Tie to ground if not used.
49	LOGLED	O	LVTTL	Internal logging status indicator, see Appendix B.	Leave unconnected if not used. Max output current: 8mA
51	TRACKLED	O	LVTTL	Tracking status indicator, see Appendix B.	Leave unconnected if not used. Max output current: 8mA
53	GPI	O	LVTTL	GPI in <b>setGPIOFunctionality</b> command.	Leave unconnected if not used. Max output current: 8mA
55	EXTREF_STAT	I	LVTTL	Used to indicate the source of the 10-MHz frequency reference (internal or external).	Leave unconnected to use the internal frequency reference, or tie to ground otherwise (see also section A.3).
57	Gnd	Gnd	0	Ground.	All ground pins must be connected.
59	Reserved			Reserved for future use	Leave unconnected.
61	SPI1_MOSI	O	LVTTL	µC SPI1 Master Out Slave In. The receiver is the SPI master. Max data rate 25Mbit/s.	Leave unconnected, or connect to SI of a SPI slave device.
63	SPI1_SCK	O	LVTTL	µC SPI1 SCK. The receiver is the SPI master. Max data rate 25Mbit/s.	Leave unconnected, or connect to SCK of a SPI slave device.
65	Reserved			Reserved for future use	Leave unconnected.
67	Gnd	Gnd	0	Ground.	All ground pins must be connected.
69	TTLnRS232	I	LVTTL	TTL vs RS232 selection for COM1 and COM2	Leave unconnected to enable COM1&2 RX lines on pins #19 and #21. Tie to ground to enable COM1&2 RX lines on pins #76 and #80.
71	Reserved			Reserved for future use	Leave unconnected.
73	ETH_TX+	O	10Base-T	Ethernet TX+ (active only on AsteRx2eL_OEM and AsteRx2eH_OEM)	Leave unconnected if not used. See section A.4 otherwise.
75	ETH_TX-	O	10Base-T	Ethernet TX- (active only on AsteRx2eL_OEM and AsteRx2eH_OEM)	Leave unconnected if not used. See section A.4 otherwise.
77	ETH_RX+	I	10Base-T	Ethernet RX+ (active only on AsteRx2eL_OEM and AsteRx2eH_OEM)	Leave unconnected if not used. See section A.4 otherwise.
79	ETH_RX-	I	10Base-T	Ethernet RX- (active only on AsteRx2eL_OEM and AsteRx2eH_OEM)	Leave unconnected if not used. See section A.4 otherwise.

### A.3 Frequency Reference Selection

The receiver can get its 10-MHz frequency reference from its internal TCXO, or from an external reference source. The involved pins are pins#39, #43 and #55. The diagrams below show the recommended connections for both cases.

The internal TCXO is turned off when using an external 10-MHz reference, and the output at pin#39 is disabled.

#### Internal frequency reference

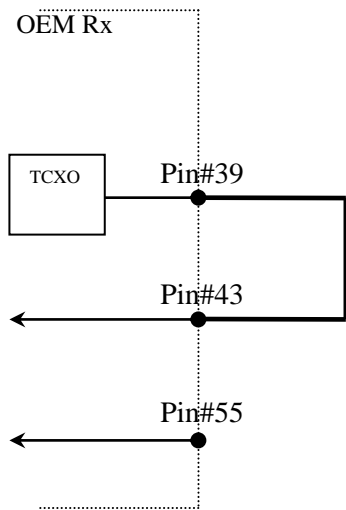

#### External frequency reference

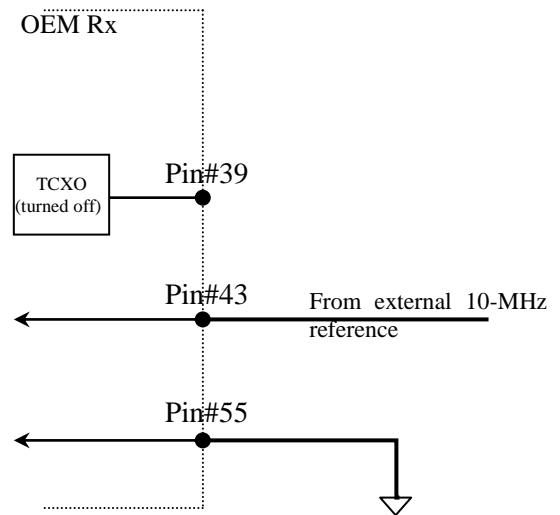

### A.4 Ethernet (only for AsteRx2eL\_OEM and AsteRx2eH\_OEM)

**!** There is no isolation transformer on the OEM board.

The applicable turns ratio are 1:2.5 for the transmit lines and 1:1 for the receive lines.

An exemplary 10Baset-T application circuit with isolation transformer is shown below. The four lines at the left are connected to the pins#73, #75, #77 and #79 of the 80-pin connector. The four lines at the right can be connected to a RJ-45 plug.

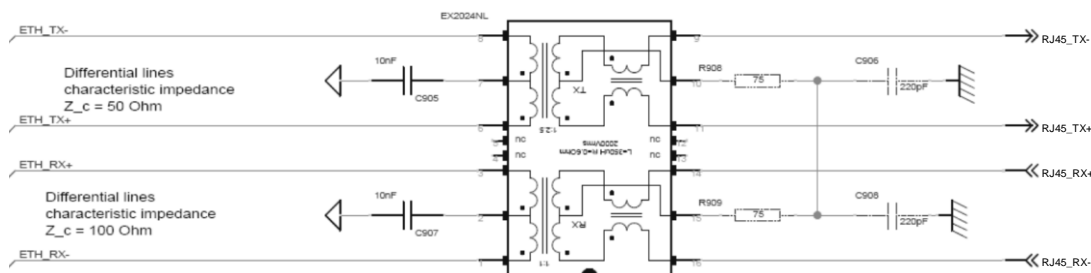

### A.5 Stand-By Mode

In stand-by mode, the receiver consumes a fraction of its nominal power.

There are two ways to request the receiver to enter stand-by mode:

1. by using the command “**exePowerMode**” (see Command Line Interface Reference Guide);

2. by shortly driving pin#8 (nPOWER\_TOGGLE) low as indicated in section A.2.

After having requested to enter stand-by mode, it takes up to 0.5 seconds for the receiver to actually enter low-power state. This time is required to unmount the SD memory card and stop all software activities.

Waking up from stand-by mode is done in one of the following ways:

1. by sending one or more characters to the first serial port (COM1) at a baud rate lower than 4800baud;
2. by shortly driving pin#8 (nPOWER\_TOGGLE) low.

Note that if the receiver has been set in stand-by mode by the command “**exePowerMode, ScheduledSleep**”, it will wake up automatically after a prescribed amount of time.

## A.6 SD Memory Card Usage

The receiver can interface to an external SD memory card through the SPI-related pins of the 80-pin connector. The recommended circuit to a 9-pin SD memory card socket is shown below. The four SPI lines connect to pins#61, #62, #63 and #64 of the 80-pin connector.

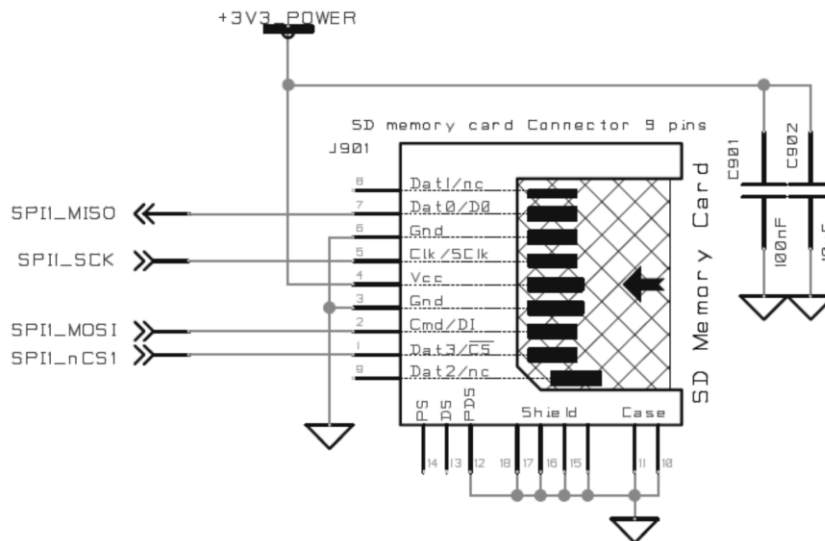

When using SD memory card logging, please take note of the following:

1. SDHC cards are not supported on firmware versions prior to 2.3.
2. The file system (FAT) is intended to not remove the card: the read-out of the data should be done through the serial or USB interfaces.
3. To avoid data corruption, the card needs to be correctly unmounted before turning off the power supply. This can be done in two ways:
  - a. By entering the “**exePowerMode, StandBy**” command before turning off the receiver.
  - b. By having a sufficient reserve to power the receiver for at least 0.5 seconds after the disconnection of the main power (e.g. with capacitors). Using pin#8 (nPWR\_TOGGLE), an indication needs to be given that the power will be turned off.

All log files are stored in the following directory on the card:

Receiver model	log file directory
AsteRx2e_OEM	/ssn/SSRC1
AsteRx2i_OEM	/ssn/SSRC1
AsteRx2eL_OEM	/ssn/SSRC3
AsteRx2eH_OEM	/ssn/SSRC2

Please note that some SD memory cards may not be compatible with Septentrio receivers. The following card types have been successfully tested:

XceedSD	SDHC 2GB
SanDisk	SDHC 4GB
Kingston	SDHC 16GB
STEC	SD 1GB
SMART	SD 1GB
SanDisk	SD 256MB
SanDisk	SDHC 16GB
SanDisk	SDHC 32GB



## Appendix B LED Status Indicators

LEDs (Light Emitting Diodes) report the status of key processes inside the receiver. On OEM boards, these LEDs are not present but output pins are reserved to drive external LEDs (max drive current 8mA).

It is assumed that the LED lights when the electrical level of the corresponding pin is high.

LED Name	LED Behaviour																
POWERLED	LED lights when the receiver is switched on.																
LOGLED	LED lights when data is being written to the internal SD memory card. If the logging rate is larger than 1 Hz, LED lights continuously.																
PVTLED	LED lights when a PVT solution is available.																
GPLED	General-purpose LED. The function of this LED is configured with the <b>setLEDMode</b> command. By default, this LED has the DIFFCORLED function (see below).																
DIFFCORLED	<p>Differential correction indicator. In rover PVT mode, this LED reports the number of satellites for which differential corrections have been provided in the last received differential correction message (RTCM or CMR).</p> <table border="1"> <thead> <tr> <th>LED behaviour</th> <th>Number of satellites with corrections</th> </tr> </thead> <tbody> <tr> <td>LED is off</td> <td>No differential correction message received</td> </tr> <tr> <td>blinks fast and continuously (10 times per second)</td> <td>0</td> </tr> <tr> <td>blinks once, then pauses</td> <td>1, 2</td> </tr> <tr> <td>blinks twice, then pauses</td> <td>3, 4</td> </tr> <tr> <td>blinks 3 times, then pauses</td> <td>5, 6</td> </tr> <tr> <td>blinks 4 times, then pauses</td> <td>7, 8</td> </tr> <tr> <td>blinks 5 times, then pauses</td> <td>9 or more</td> </tr> </tbody> </table> <p>The LED is solid 'ON' when the receiver is outputting differential corrections as a static base station.</p>	LED behaviour	Number of satellites with corrections	LED is off	No differential correction message received	blinks fast and continuously (10 times per second)	0	blinks once, then pauses	1, 2	blinks twice, then pauses	3, 4	blinks 3 times, then pauses	5, 6	blinks 4 times, then pauses	7, 8	blinks 5 times, then pauses	9 or more
LED behaviour	Number of satellites with corrections																
LED is off	No differential correction message received																
blinks fast and continuously (10 times per second)	0																
blinks once, then pauses	1, 2																
blinks twice, then pauses	3, 4																
blinks 3 times, then pauses	5, 6																
blinks 4 times, then pauses	7, 8																
blinks 5 times, then pauses	9 or more																
TRACKLED	<table border="1"> <thead> <tr> <th>LED behaviour</th> <th>Number of satellites in tracking</th> </tr> </thead> <tbody> <tr> <td>blinks fast and continuously (10 times per second)</td> <td>0</td> </tr> <tr> <td>blinks once, then pauses</td> <td>1, 2</td> </tr> <tr> <td>blinks twice, then pauses</td> <td>3, 4</td> </tr> <tr> <td>blinks 3 times, then pauses</td> <td>5, 6</td> </tr> <tr> <td>blinks 4 times, then pauses</td> <td>7, 8</td> </tr> <tr> <td>blinks 5 times, then pauses</td> <td>9 or more</td> </tr> </tbody> </table>	LED behaviour	Number of satellites in tracking	blinks fast and continuously (10 times per second)	0	blinks once, then pauses	1, 2	blinks twice, then pauses	3, 4	blinks 3 times, then pauses	5, 6	blinks 4 times, then pauses	7, 8	blinks 5 times, then pauses	9 or more		
LED behaviour	Number of satellites in tracking																
blinks fast and continuously (10 times per second)	0																
blinks once, then pauses	1, 2																
blinks twice, then pauses	3, 4																
blinks 3 times, then pauses	5, 6																
blinks 4 times, then pauses	7, 8																
blinks 5 times, then pauses	9 or more																